

JB SANITARY

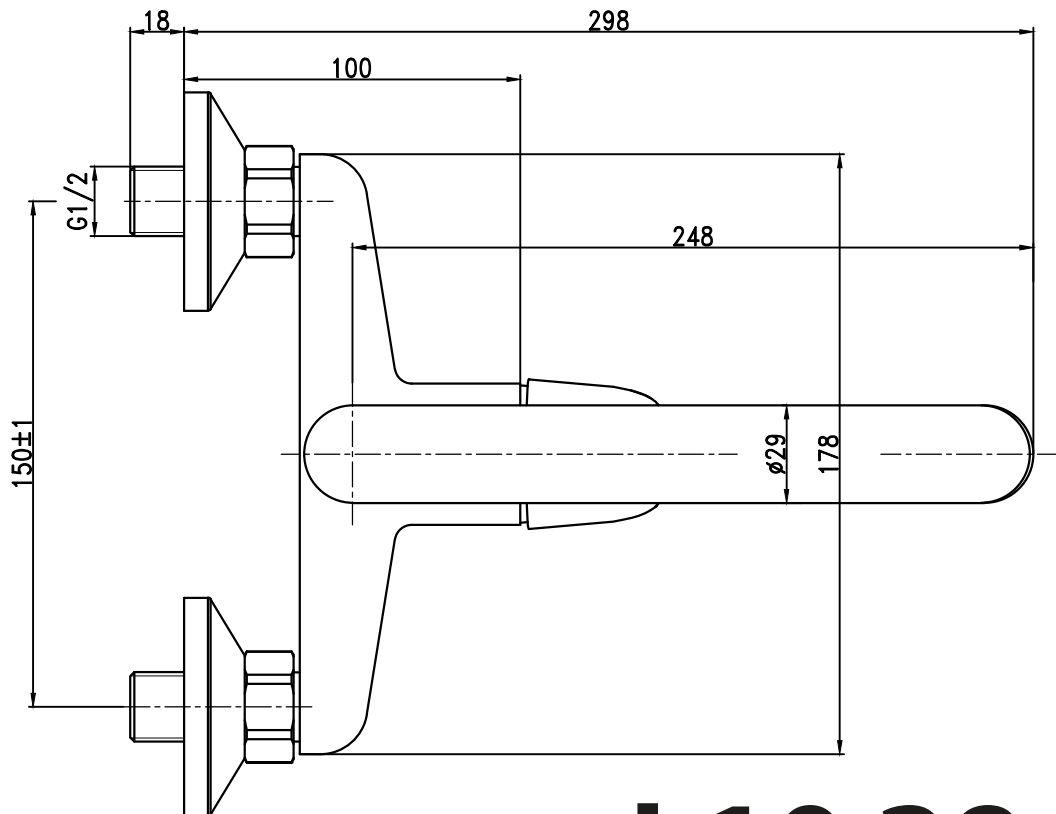
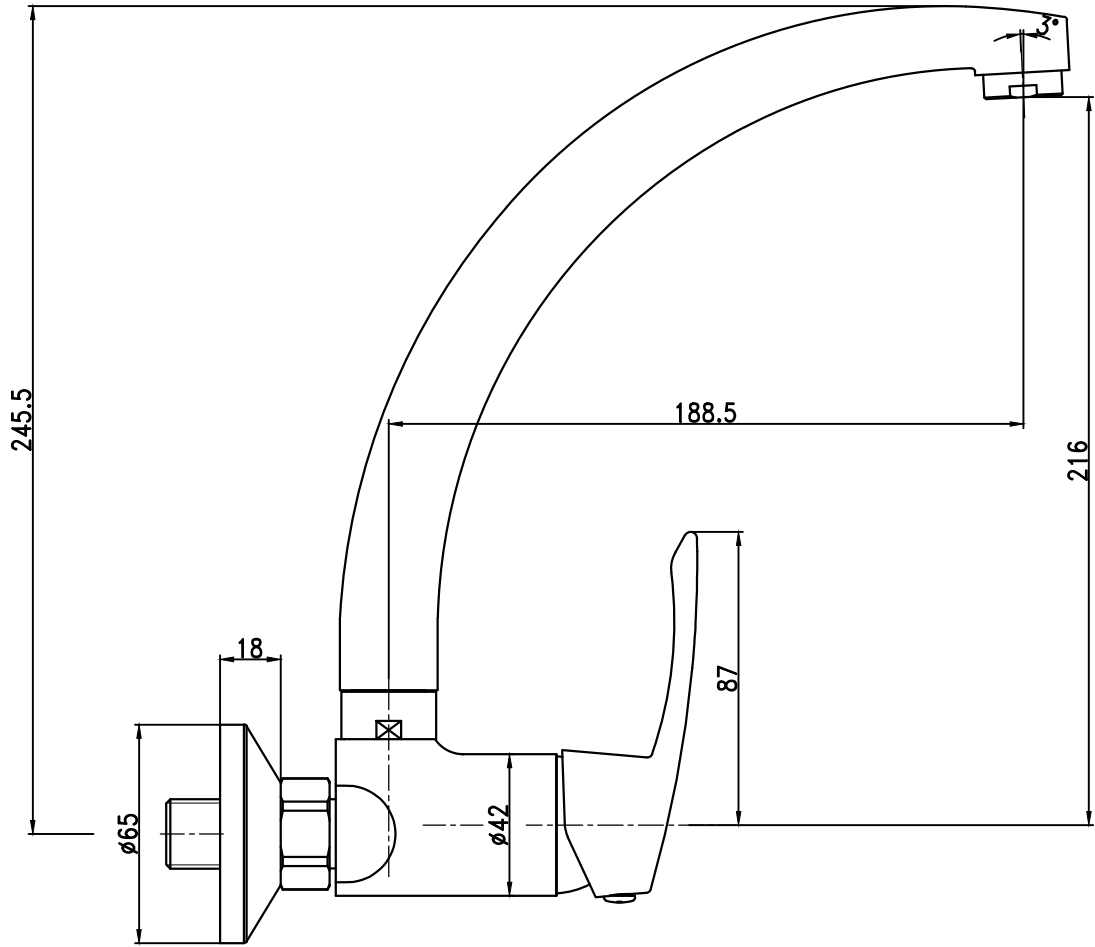

L10 38 80